

Product datasheet

Specifications



controller M221 16 IO relay Ethernet

TM221CE16R

Main

| | |
|---------------------------|--|
| Range of product | Modicon M221 |
| Product or component type | Logic controller |
| [Us] rated supply voltage | 100...240 V AC |
| Discrete input number | 9, discrete input conforming to IEC 61131-2 Type 1 |
| Analogue input number | 2 at 0...10 V |
| Discrete output type | Relay normally open |
| Discrete output number | 7 relay |
| Discrete output voltage | 5...125 V DC 5...250 V AC |
| Discrete output current | 2 A |

Complementary

| | |
|--|---|
| Discrete I/O number | 16 |
| Maximum number of I/O expansion module | 4 (local I/O-Architecture) 11 (remote I/O-Architecture) |
| Supply voltage limits | 85...264 V |
| Network frequency | 50/60 Hz |
| Inrush current | 40 A |
| Maximum power consumption in VA | 49 VA at 100...240 V with max number of I/O expansion module 33 VA at 100...240 V without I/O expansion module |
| Power supply output current | 0.325 A 5 V for expansion bus 0.12 A 24 V for expansion bus |
| Discrete input logic | Sink or source (positive/negative) |
| Discrete input voltage | 24 V |
| Discrete input voltage type | DC |
| Analogue input resolution | 10 bits |
| LSB value | 10 mV |
| Conversion time | 1 ms per channel + 1 controller cycle time for analogue input analog input |
| Permitted overload on inputs | +/- 30 V DC for 5 min (maximum) for analog input +/- 13 V DC (permanent) for analog input |
| Voltage state 1 guaranteed | ≥ 15 V for input |
| Voltage state 0 guaranteed | ≤ 5 V for input |

| | |
|--|---|
| Discrete input current | 7 mA for discrete input 5 mA for fast input |
| Input impedance | 3.4 kOhm for discrete input 100 kOhm for analog input 4.9 kOhm for fast input |
| Response time | 35 µs turn-off, I2...I5 terminal(s) for input 10 ms turn-on for output 10 ms turn-off for output 5 µs turn-on, I0, I1, I6, I7 terminal(s) for fast input 35 µs turn-on, other terminals terminal(s) for input 5 µs turn-off, I0, I1, I6, I7 terminal(s) for fast input 100 µs turn-off, other terminals terminal(s) for input |
| Configurable filtering time | 0 ms for input 3 ms for input 12 ms for input |
| Output voltage limits | 125 V DC 277 V AC |
| Maximum current per output common | 6 A at COM 1 7 A at COM 0 |
| Absolute accuracy error | +/- 1 % of full scale for analog input |
| Electrical durability | 100000 cycles AC-12, 120 V, 240 VA, resistive 100000 cycles AC-12, 240 V, 480 VA, resistive 300000 cycles AC-12, 120 V, 80 VA, resistive 300000 cycles AC-12, 240 V, 160 VA, resistive 100000 cycles AC-15, cos phi = 0.35, 120 V, 60 VA, inductive 100000 cycles AC-15, cos phi = 0.35, 240 V, 120 VA, inductive 300000 cycles AC-15, cos phi = 0.35, 120 V, 18 VA, inductive 300000 cycles AC-15, cos phi = 0.35, 240 V, 36 VA, inductive 100000 cycles AC-14, cos phi = 0.7, 120 V, 120 VA, inductive 100000 cycles AC-14, cos phi = 0.7, 240 V, 240 VA, inductive 300000 cycles AC-14, cos phi = 0.7, 120 V, 36 VA, inductive 300000 cycles AC-14, cos phi = 0.7, 240 V, 72 VA, inductive 100000 cycles DC-12, 24 V, 48 W, resistive 300000 cycles DC-12, 24 V, 16 W, resistive 100000 cycles DC-13, 24 V, 24 W, inductive (L/R = 7 ms) 300000 cycles DC-13, 24 V, 7.2 W, inductive (L/R = 7 ms) |
| Switching frequency | 20 switching operations/minute with maximum load |
| Mechanical durability | 20000000 cycles for relay output |
| Minimum load | 1 mA at 5 V DC for relay output |
| Protection type | Without protection at 5 A |
| Reset time | 1 s |
| Memory capacity | 256 kB for user application and data RAM with 10000 instructions 256 kB for internal variables RAM |
| Data backed up | 256 kB built-in flash memory for backup of application and data |
| Data storage equipment | 2 GB SD card (optional) |
| Battery type | BR2032 or CR2032X lithium non-rechargeable |
| Backup time | 1 year at 25 °C (by interruption of power supply) |
| Execution time for 1 KInstruction | 0.3 ms for event and periodic task |
| Execution time per instruction | 0.2 µs Boolean |
| Exct time for event task | 60 µs response time |
| Maximum size of object areas | 255 %C counters 512 %KW constant words 255 %TM timers 512 %M memory bits 8000 %MW memory words |
| Realtime clock | With |
| Clock drift | <= 30 s/month at 25 °C |
| Regulation loop | Adjustable PID regulator up to 14 simultaneous loops |
| Counting input number | 4 fast input (HSC mode) at 100 kHz 32 bits |
| Counter function | Pulse/direction A/B |

Single phase

| | |
|---|---|
| Integrated connection type | USB port with mini B USB 2.0 connector Non isolated serial link serial 1 with RJ45 connector and RS232/RS485 interface Ethernet with RJ45 connector |
| Supply | (serial)serial link supply: 5 V, <200 mA |
| Transmission rate | 1.2...115.2 kbit/s (115.2 kbit/s by default) for bus length of 15 m for RS485 1.2...115.2 kbit/s (115.2 kbit/s by default) for bus length of 3 m for RS232 480 Mbit/s for USB |
| Communication port protocol | USB port: USB - SoMachine-Network Non isolated serial link: Modbus master/slave - RTU/ASCII or SoMachine-Network Ethernet |
| Port Ethernet | 10BASE-T/100BASE-TX 1 port with 100 m copper cable |
| Communication service | DHCP client Ethernet/IP adapter Modbus TCP server Modbus TCP slave device Modbus TCP client |
| Local signalling | 1 LED (green) for PWR 1 LED (green) for RUN 1 LED (red) for module error (ERR) 1 LED (green) for SD card access (SD) 1 LED (red) for BAT 1 LED per channel (green) for I/O state 1 LED (green) for SL Ethernet network activity (green) for ACT Ethernet network link (yellow) for Link (Link Status) |
| Electrical connection | removable screw terminal block for inputs removable screw terminal block for outputs terminal block, 3 terminal(s) for connecting the 24 V DC power supply connector, 4 terminal(s) for analogue inputs Mini B USB 2.0 connector for a programming terminal |
| Maximum cable distance between devices | Shielded cable: <10 m for fast input Unshielded cable: <30 m for output Unshielded cable: <30 m for digital input Unshielded cable: <1 m for analog input |
| Insulation | Between input and internal logic at 500 V AC Non-insulated between analogue input and internal logic Non-insulated between analogue inputs Between supply and ground at 1500 V AC Between sensor power supply and ground at 500 V AC Between input and ground at 500 V AC Between output and ground at 1500 V AC Between supply and internal logic at 2300 V AC Between sensor power supply and internal logic at 500 V AC Between output and internal logic at 2300 V AC Between Ethernet terminal and internal logic at 500 V AC Between supply and sensor power supply at 2300 V AC |
| Marking | CE |
| Sensor power supply | 24 V DC at 250 mA supplied by the controller |
| Mounting support | Top hat type TH35-15 rail conforming to IEC 60715 Top hat type TH35-7.5 rail conforming to IEC 60715 plate or panel with fixing kit |
| Height | 90 mm |
| Depth | 70 mm |
| Width | 95 mm |
| Net weight | 0.346 kg |

Environment

| | |
|-------------------------------|--|
| Standards | EN/IEC 61131-2 UL 508 CAN/CSA C22.2 No. 213 IACS E10 ANSI/ISA 12-12-01 |
| Product certifications | cULus LR RCM EAC ABS DNV-GL CE |

| | |
|--|--|
| Environmental characteristic | Ordinary and hazardous location |
| Resistance to electrostatic discharge | 8 kV in air conforming to EN/IEC 61000-4-2 4 kV on contact conforming to EN/IEC 61000-4-2 |
| Resistance to electromagnetic fields | 10 V/m 80 MHz...1 GHz conforming to EN/IEC 61000-4-3 3 V/m 1.4 GHz...2 GHz conforming to EN/IEC 61000-4-3 1 V/m 2...2.7 GHz conforming to EN/IEC 61000-4-3 |
| Resistance to magnetic fields | 30 A/m 50/60 Hz conforming to EN/IEC 61000-4-8 |
| Resistance to fast transients | 2 kV (power lines) conforming to EN/IEC 61000-4-4 2 kV (relay output) conforming to EN/IEC 61000-4-4 1 kV (I/O) conforming to EN/IEC 61000-4-4 1 kV (Ethernet line) conforming to EN/IEC 61000-4-4 1 kV (serial link) conforming to EN/IEC 61000-4-4 |
| Surge withstand | 2 kV power lines (AC) common mode conforming to EN/IEC 61000-4-5 2 kV relay output common mode conforming to EN/IEC 61000-4-5 1 kV I/O common mode conforming to EN/IEC 61000-4-5 1 kV shielded cable common mode conforming to EN/IEC 61000-4-5 0.5 kV power lines (DC) differential mode conforming to EN/IEC 61000-4-5 1 kV power lines (AC) differential mode conforming to EN/IEC 61000-4-5 1 kV relay output differential mode conforming to EN/IEC 61000-4-5 0.5 kV power lines (DC) common mode conforming to EN/IEC 61000-4-5 |
| Resistance to conducted disturbances | 10 V 0.15...80 MHz conforming to EN/IEC 61000-4-6 3 V 0.1...80 MHz conforming to Marine specification (LR, ABS, DNV, GL) 10 V spot frequency (2, 3, 4, 6.2, 8.2, 12.6, 16.5, 18.8, 22, 25 MHz) conforming to Marine specification (LR, ABS, DNV, GL) |
| Electromagnetic emission | Conducted emissions - test level: 79 dB μ V/m QP/66 dB μ V/m AV (power lines (AC)) at 0.15...0.5 MHz conforming to EN/IEC 55011 Conducted emissions - test level: 73 dB μ V/m QP/60 dB μ V/m AV (power lines (AC)) at 0.5...300 MHz conforming to EN/IEC 55011 Conducted emissions - test level: 120...69 dB μ V/m QP (power lines) at 10...150 kHz conforming to EN/IEC 55011 Conducted emissions - test level: 63 dB μ V/m QP (power lines) at 1.5...30 MHz conforming to EN/IEC 55011 Radiated emissions - test level: 40 dB μ V/m QP class A (10 m) at 30...230 MHz conforming to EN/IEC 55011 Conducted emissions - test level: 79...63 dB μ V/m QP (power lines) at 150...1500 kHz conforming to EN/IEC 55011 Radiated emissions - test level: 47 dB μ V/m QP class A (10 m) at 200...1000 MHz conforming to EN/IEC 55011 |
| Immunity to microbreaks | 10 ms |
| Ambient air temperature for operation | -10...55 °C (horizontal installation) -10...35 °C (vertical installation) |
| Ambient air temperature for storage | -25...70 °C |
| Relative humidity | 10...95 %, without condensation (in operation) 10...95 %, without condensation (in storage) |
| IP degree of protection | IP20 with protective cover in place |
| Pollution degree | <= 2 |
| Operating altitude | 0...2000 m |
| Storage altitude | 0...3000 m |
| Vibration resistance | 3.5 mm at 5...8.4 Hz on symmetrical rail 3.5 mm at 5...8.4 Hz on panel mounting 1 gn at 8.4...150 Hz on symmetrical rail 1 gn at 8.4...150 Hz on panel mounting |
| Shock resistance | 98 m/s ² for 11 ms |

Packing Units

| | |
|-------------------------------------|-----------|
| Unit Type of Package 1 | PCE |
| Number of Units in Package 1 | 1 |
| Package 1 Height | 10.829 cm |
| Package 1 Width | 14.04 cm |
| Package 1 Length | 14.181 cm |

| | |
|------------------------------|-----------|
| Package 1 Weight | 590.0 g |
| Unit Type of Package 2 | CAR |
| Number of Units in Package 2 | 20 |
| Package 2 Height | 28.9 cm |
| Package 2 Width | 39.5 cm |
| Package 2 Length | 57.4 cm |
| Package 2 Weight | 12.771 kg |
| Unit Type of Package 3 | P12 |
| Number of Units in Package 3 | 240 |
| Package 3 Height | 105.0 cm |
| Package 3 Width | 120.0 cm |
| Package 3 Length | 80.0 cm |
| Package 3 Weight | 164 kg |

Offer Sustainability

| | |
|----------------------------|---|
| Sustainable offer status | Green Premium product |
| REACH Regulation | REACH Declaration |
| EU RoHS Directive | Pro-active compliance (Product out of EU RoHS legal scope) EU RoHS Declaration |
| Mercury free | Yes |
| China RoHS Regulation | China RoHS declaration |
| RoHS exemption information | Yes |
| Environmental Disclosure | Product Environmental Profile |
| Circularity Profile | End of Life Information |
| WEEE | The product must be disposed on European Union markets following specific waste collection and never end up in rubbish bins |
| PVC free | Yes |

Dimensions

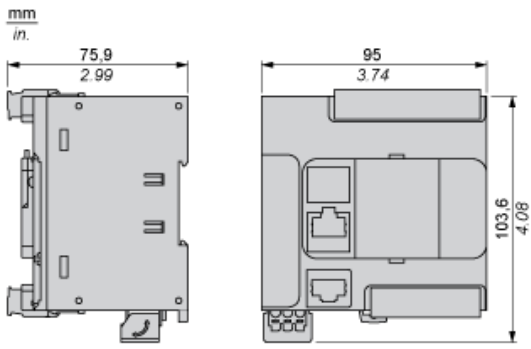

Mounting on a Rail

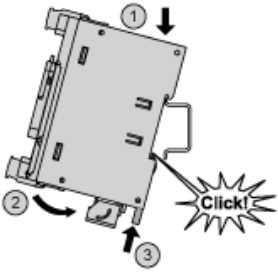

Direct Mounting on a Panel Surface

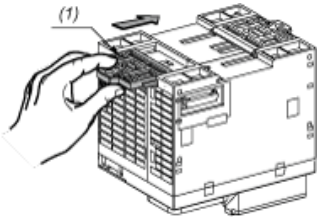

(1) Install a mounting strip

Mounting Hole Layout

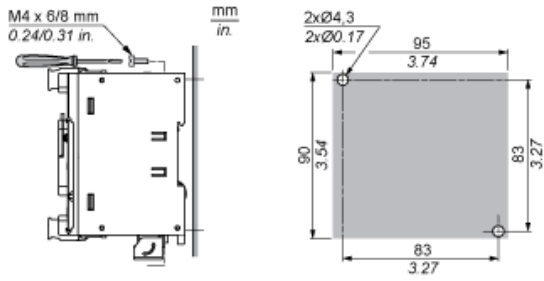

Mounting

Correct Mounting Position

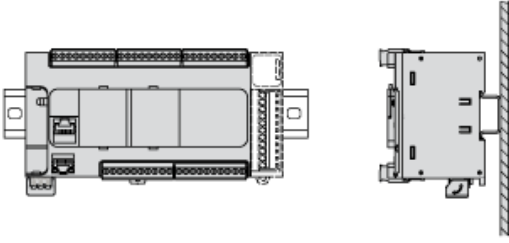

Acceptable Mounting Position

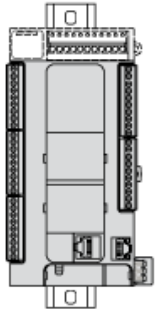

Incorrect Mounting Position

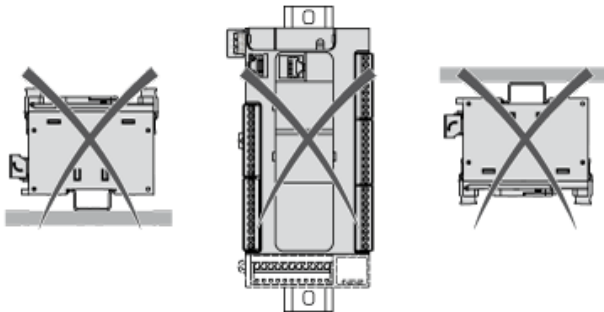

Clearance

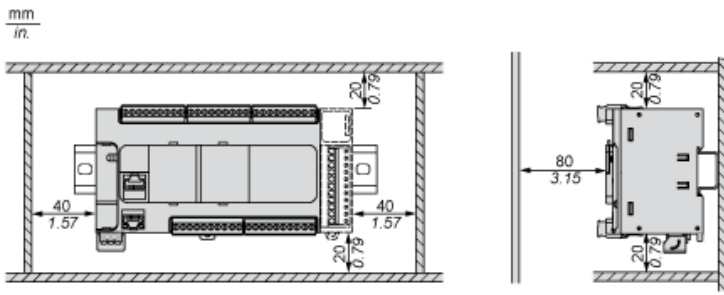

Digital Inputs

Wiring Diagram (Positive Logic)

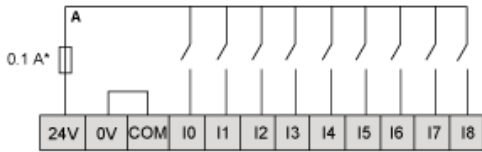

(*) Type T fuse

Wiring Diagram (Negative Logic)

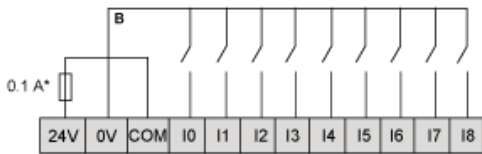

(*) Type T fuse

Connection of the Fast Inputs

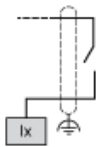

10, 11, 16, 17

Relay Outputs

Negative Logic (Sink)

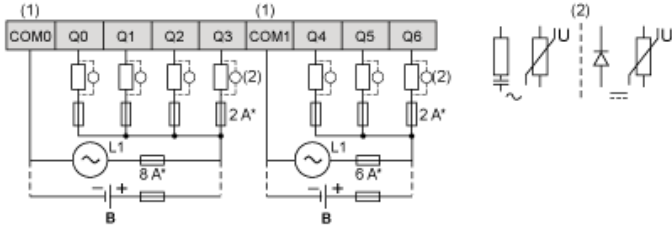

- (*) Type T fuse
- (1) The COM1 and COM2 terminals are not connected internally.
- (2) To improve the life time of the contacts, and to protect from potential inductive load damage, you must connect a free wheeling diode in parallel to the load.
- B** Sink wiring (negative logic)

Positive Logic (Source)

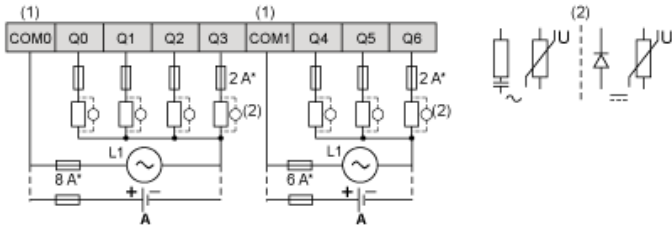

- (*) Type T fuse
- (1) The COM1 and COM2 terminals are not connected internally.
- (2) To improve the life time of the contacts, and to protect from potential inductive load damage, you must connect a free wheeling diode in parallel to the load.
- A** Source wiring (positive logic)

Analog Inputs

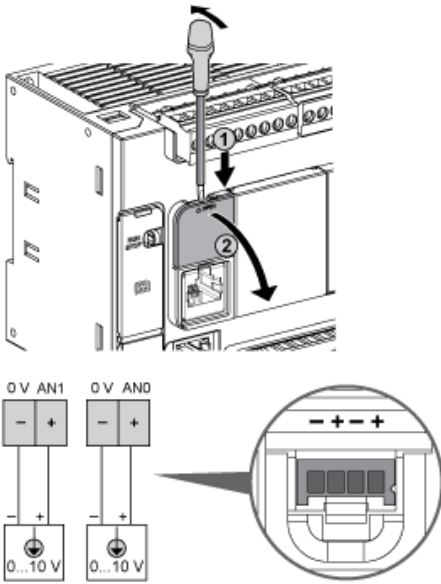

The (-) poles are connected internally.

| Pin | Wire Color |
|-----|------------|
| 0 V | Black |
| AN1 | Red |
| 0 V | Black |
| AN0 | Red |

Ethernet Connection

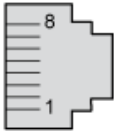

| Pin N° | Signal |
|--------|--------|
| 1 | TD+ |
| 2 | TD- |
| 3 | RD+ |
| 4 | - |
| 5 | - |
| 6 | RD- |
| 7 | - |
| 8 | - |

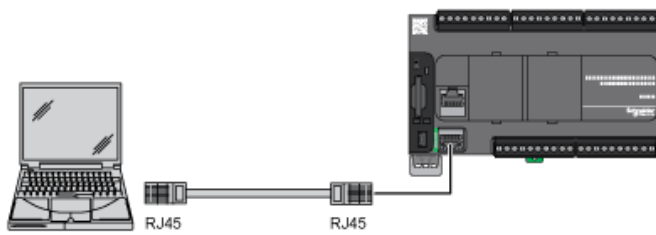

USB Mini-B Connection

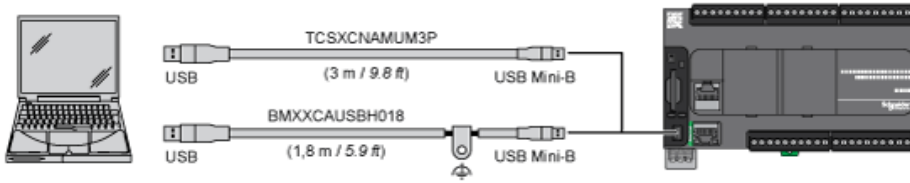

SL1 Connection

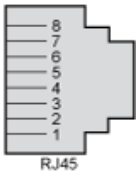

SL1

| N ° | RS 232 | RS 485 |
|-----|--------|--------|
| 1 | RxD | N.C. |
| 2 | TxD | N.C. |
| 3 | RTS | N.C. |
| 4 | N.C. | D1 |
| 5 | N.C. | D0 |
| 6 | CTS | N.C. |
| 7 | N.C.* | 5 Vdc |
| 8 | Common | Common |

N.C.: not connected

* : 5 Vdc delivered by the controller. Do not connect.

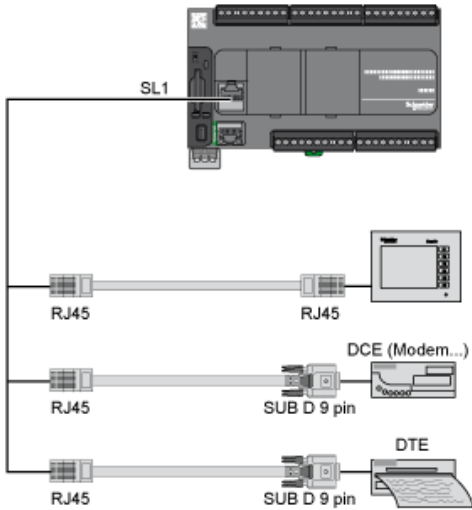

Derating Curves

Embedded Digital Inputs (No Cartridge)

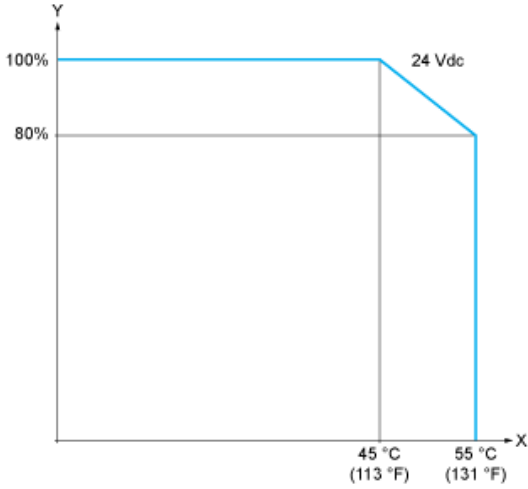

X : Ambient temperature
Y : Input simultaneous ON ratio

Embedded Digital Inputs (with Cartridge)

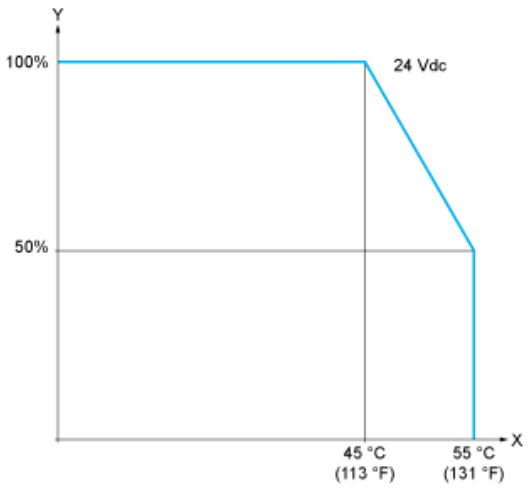

X : Ambient temperature
Y : Input simultaneous ON ratio

Recommended replacement(s)